

Kamê

35441111 • 35661111 FLOW

ASSEMBLY AND MAINTENANCE INSTRUCTION

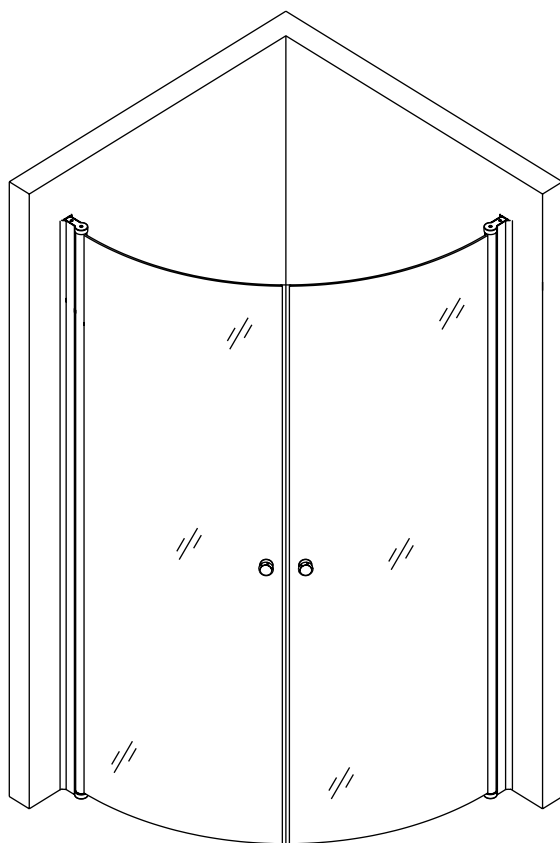

SIZE: 75x195 cm/max 77 cm
85x195 cm/max 87 cm

MAINTENANCE OF SHOWER ENCLOSURE

AFTER INSTALLATION

Seal seams of the frame with silicon. Use neutral detergent to clean the aluminium frame and glass and polish them with a soft cloth. Let the seams rest for 24 hours to guarantee the waterproof construction.

EVERYDAY CARE

Open and close doors gently to avoid the damage of the glass. Oil the sliding elements every month to guarantee the smooth sliding. Do not use acid or alkali solutions and knives to scrape the shower room. Perform gentle cleaning and maintenance periodically. Keep the door open to have the shower area well ventilated.

5
years **GUARANTEE**

Kame grants a 5 year warranty against manufacturing defects, providing the installation, cleaning and maintenance instructions are followed.

level ruler

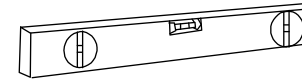

tape measure

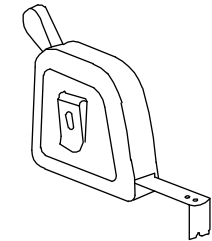

pencil



ruler



3 mm drills

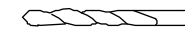

electric drill

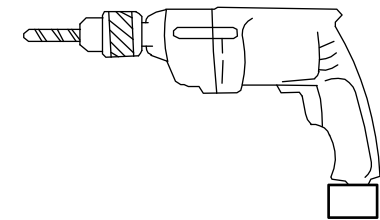

screwdrivers blades

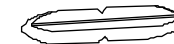

organic glass gun

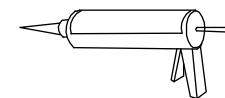

screwdriver

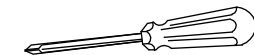



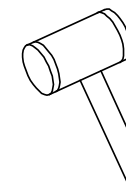



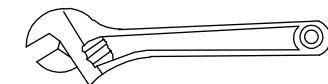

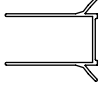
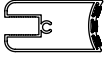
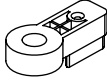
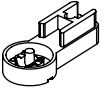





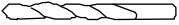

rawhide hammer

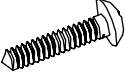

spanner



| COMPONENTS | | | |
|------------|-------------------------|---|-----|
| CODE | NAME | MODEL | QTY |
| A | Wall fixing profile |  | 2 |
| B | Vertical chrome profile |  | 2 |
| C | Frame fixer (R) |  | 2 |
| D | Frame fixer (L) |  | 2 |
| E | Outside screw cap |  | 6 |
| F | Inside screw cap |  | 6 |
| G | Sliding glass |  | 2 |
| H | Magnetic strip |  | 1 |

| COMPONENTS | | | |
|------------|----------------------|---|-----|
| CODE | NAME | MODEL | QTY |
| I | Expansion pipe screw |  | 6 |
| J | Twist drills | 3.2  | 1 |
| K | Down weather bar |  | 2 |
| L | Screw ST4x30mm |   | 6 |
| M | Screw ST4x12mm |   | 6 |
| N | Screw ST4.2x25mm |   | 4 |
| O | Handle |  | 2 |
| R | Cover cap |  | 2 |

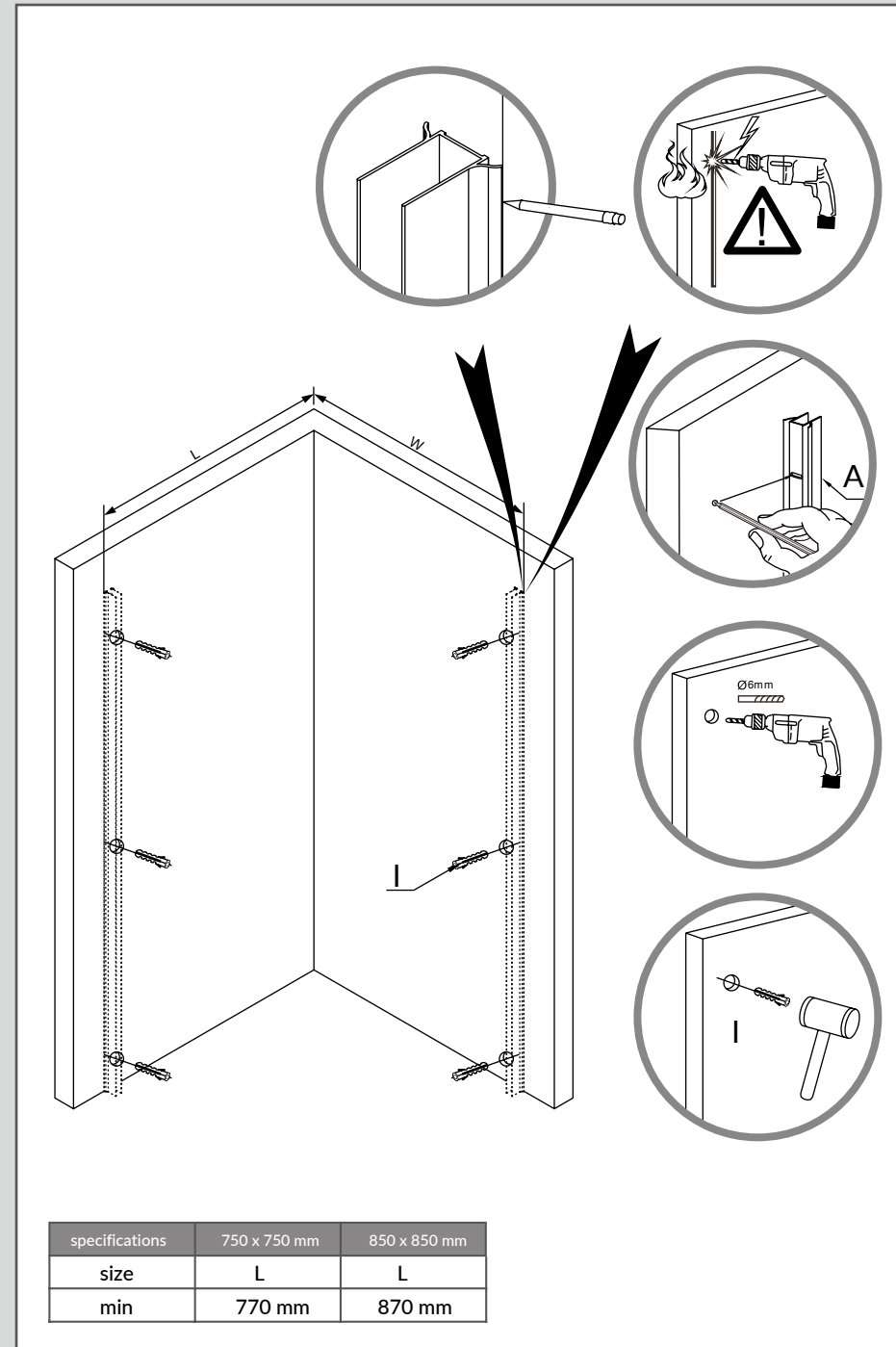
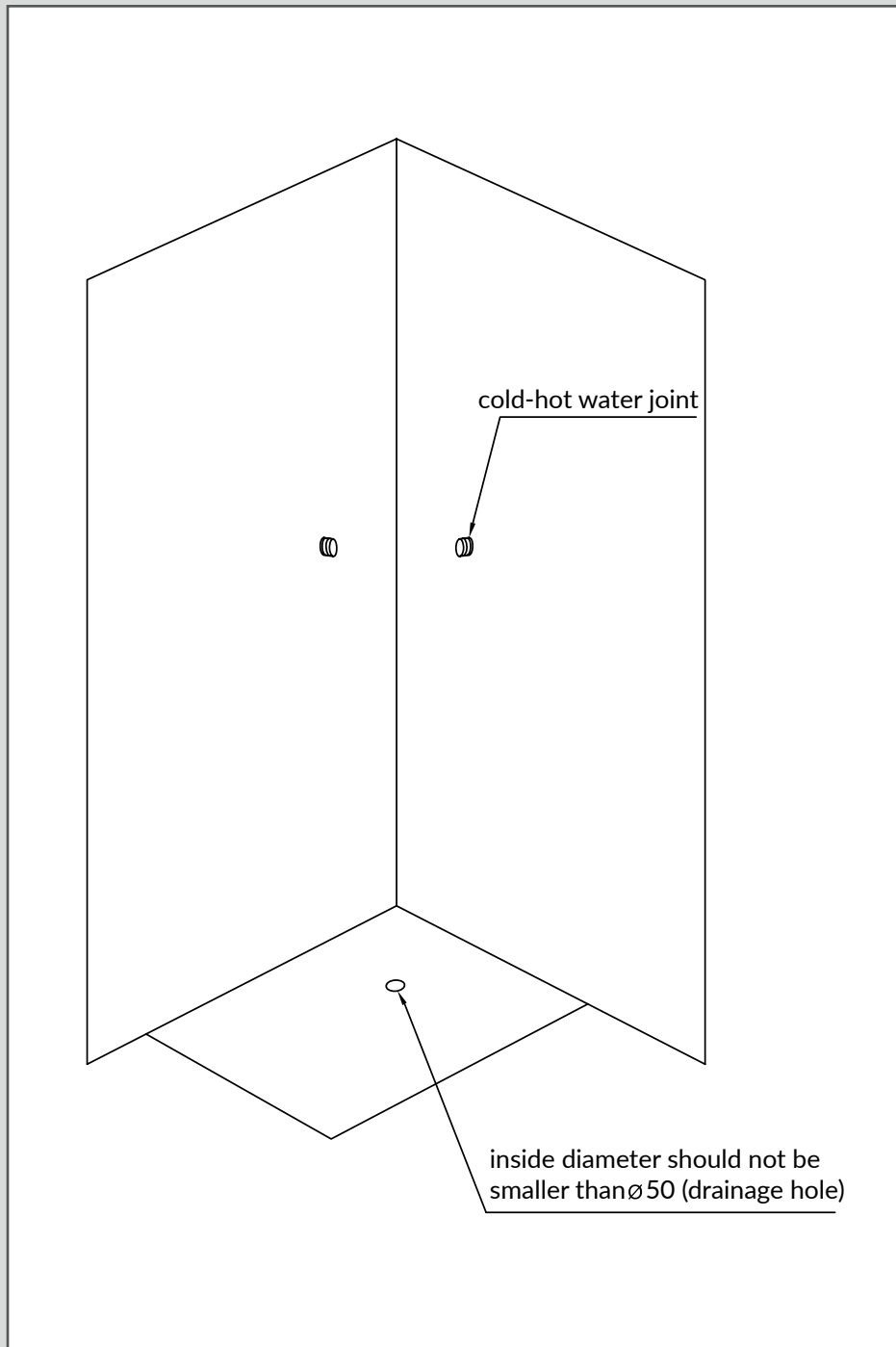

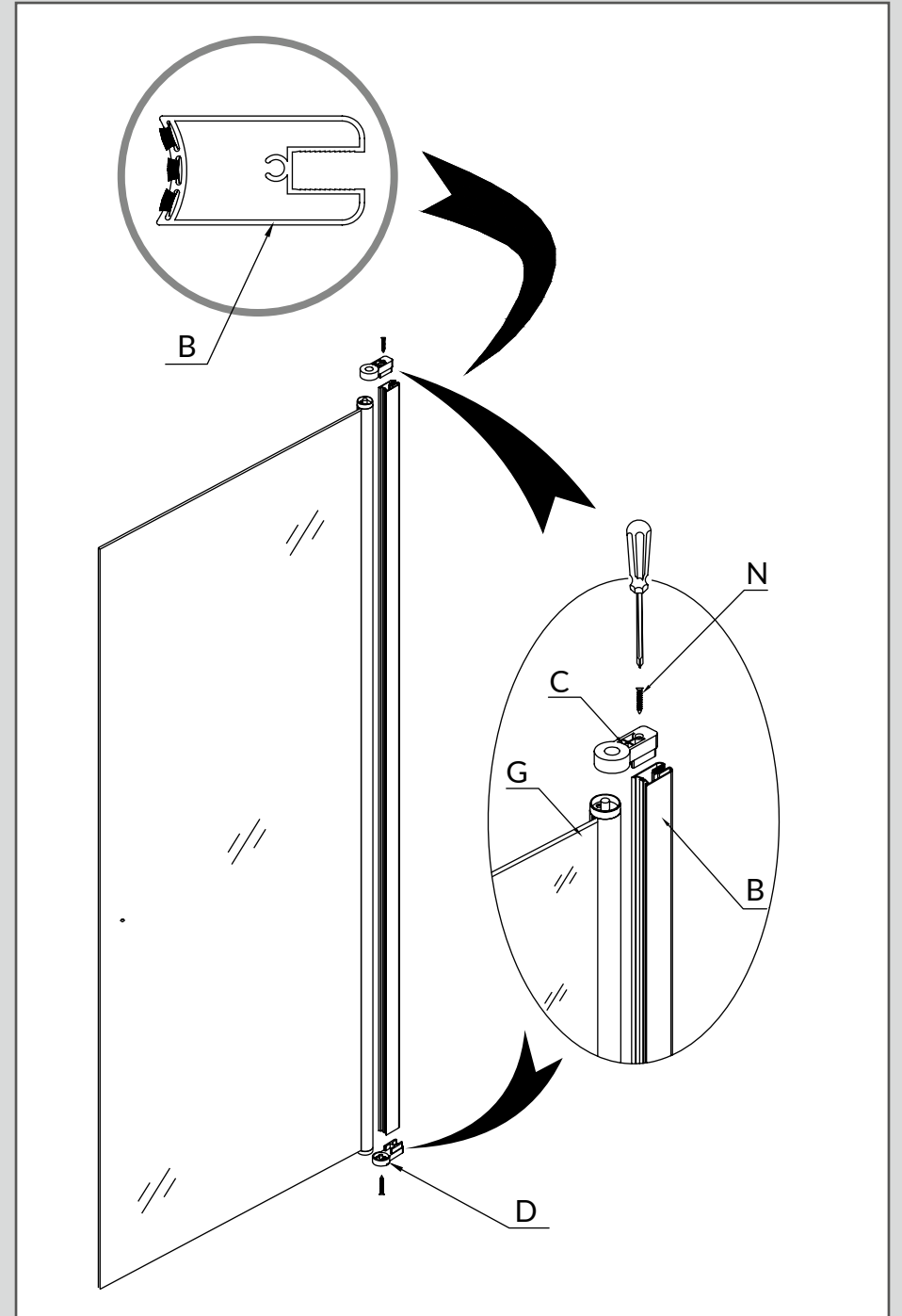
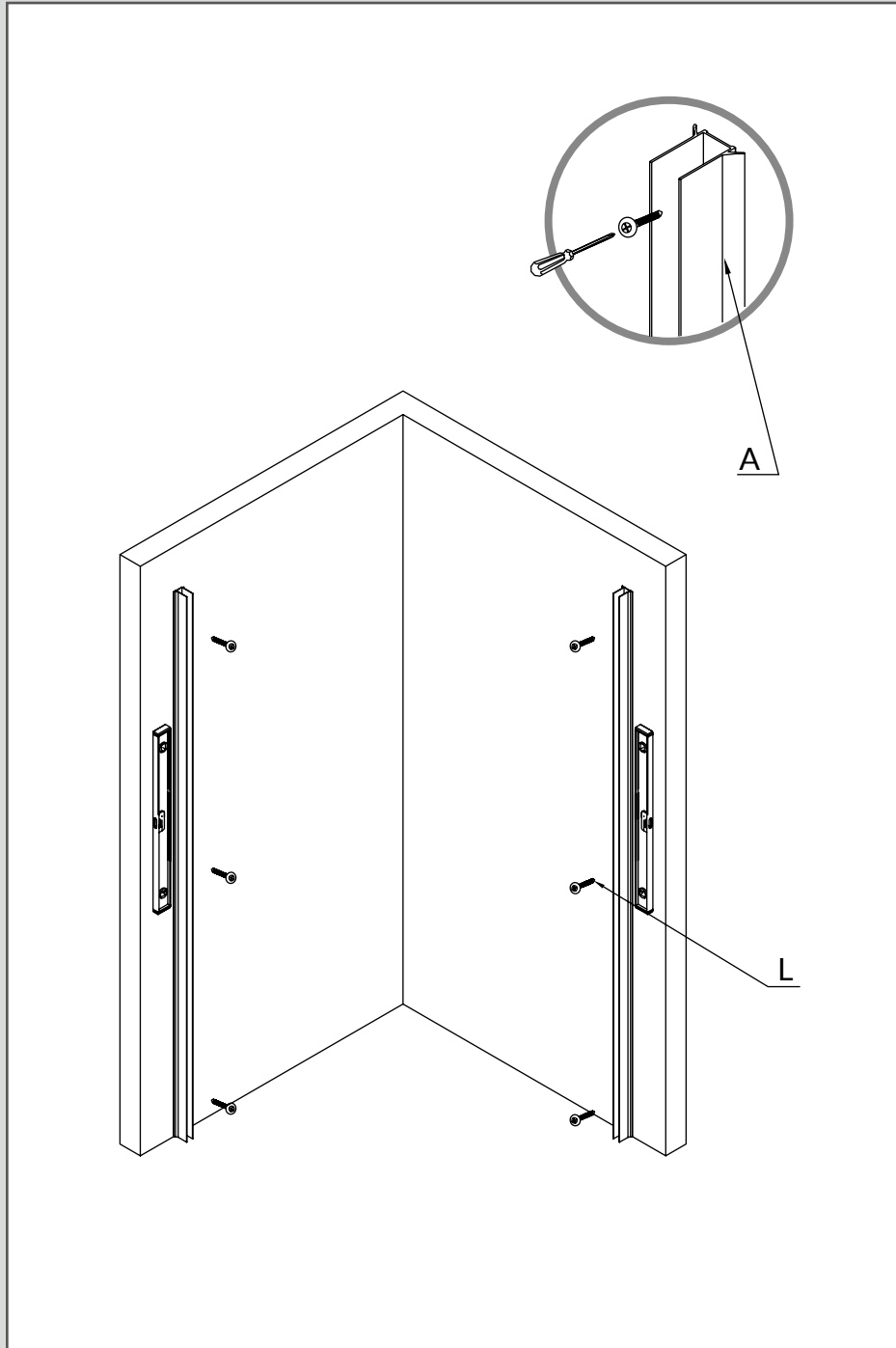

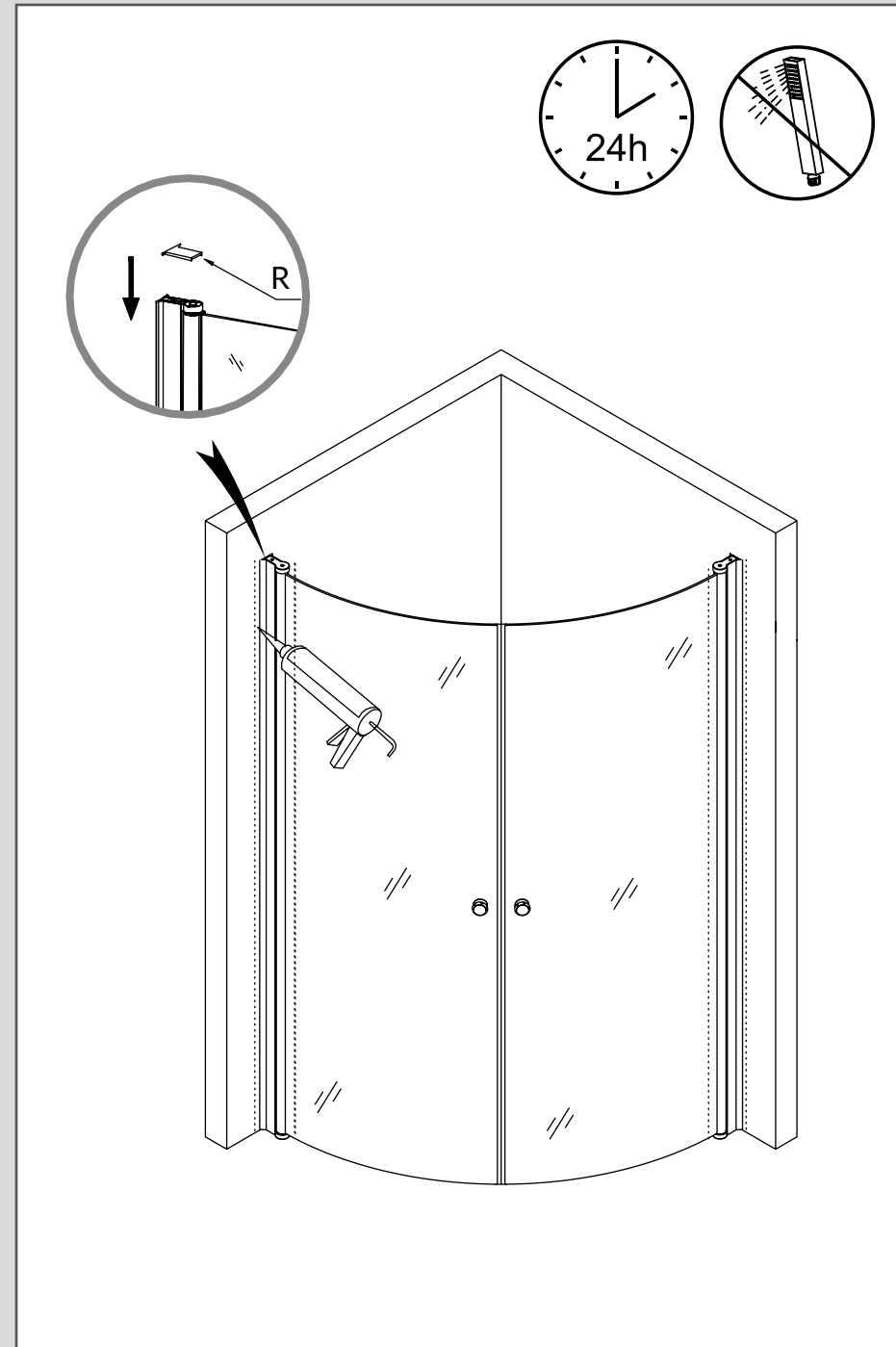
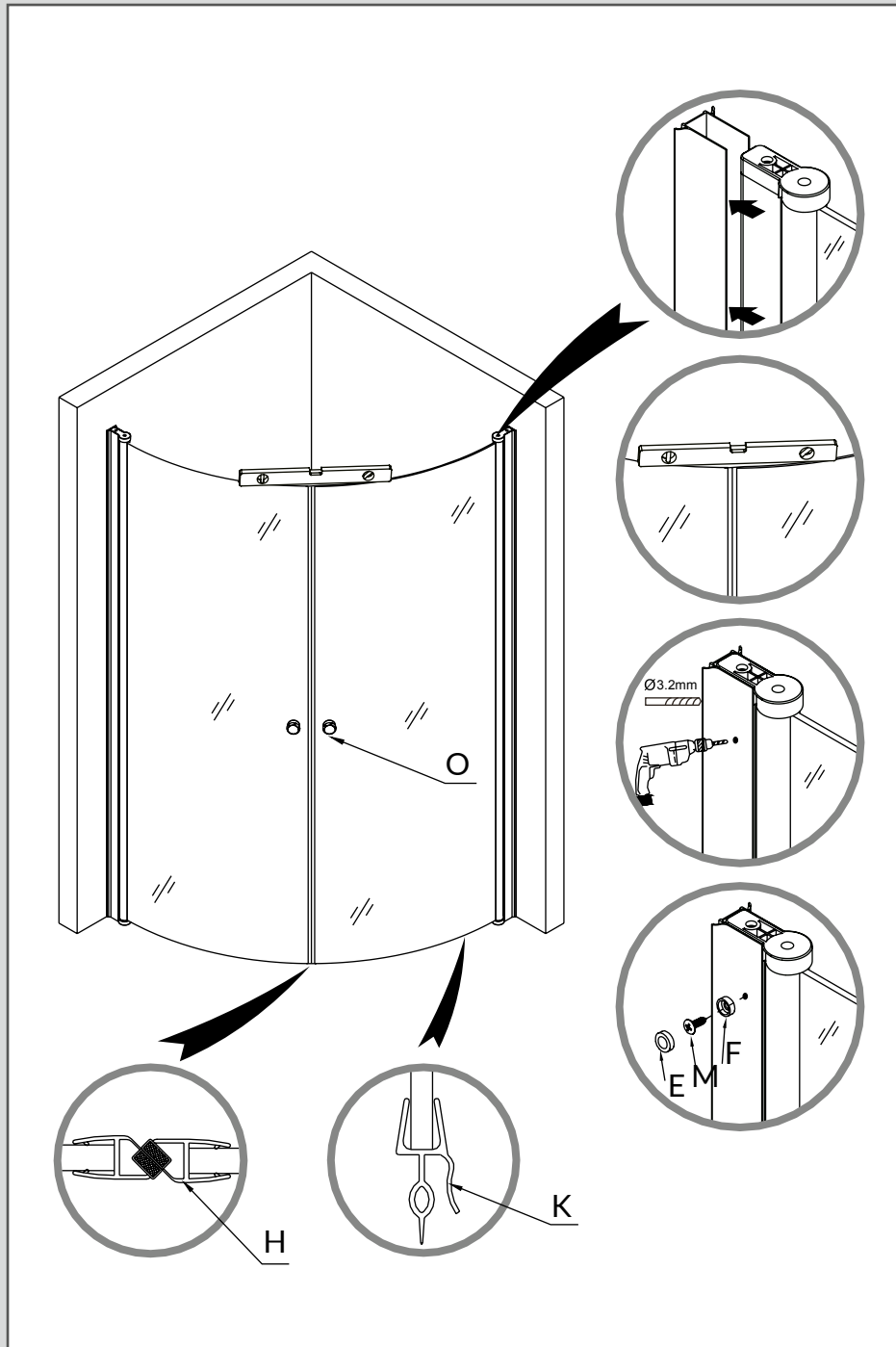

Kamė

Kamė UAB

Kokybės 4, Biruliškių km., Kauno r., LT -54469, Lithuania

Tel: +370 37 709 897 | info@kame.lt | www.kame.lt