

Kamê

65401111 • 65601111 • 65000001
DIAMOND / SOLO

ASSEMBLY AND MAINTENANCE INSTRUCTION

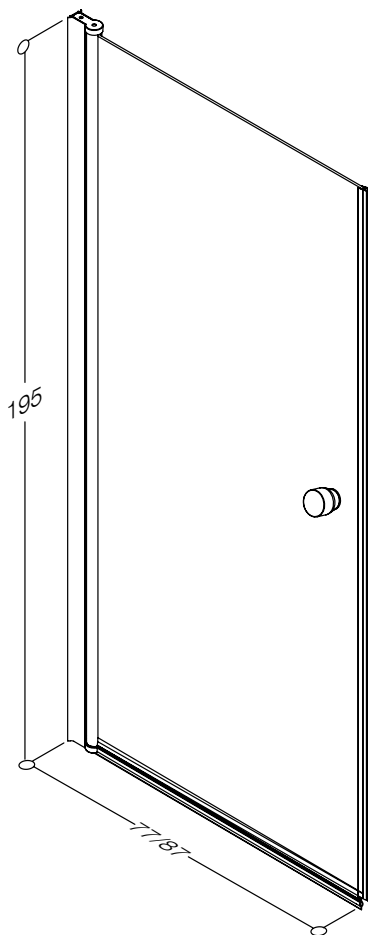

SIZE: 77x195 cm/max 79 cm
87x195 cm/max 89 cm

MAINTENANCE OF SHOWER ENCLOSURE

AFTER INSTALLATION

Seal seams of the frame with silicon. Use neutral detergent to clean the aluminium frame and glass and polish them with a soft cloth. Let the seams rest for 24 hours to guarantee the waterproof construction.

EVERYDAY CARE

Open and close doors gently to avoid the damage of the glass. Oil the sliding elements every month to guarantee the smooth sliding. Do not use acid or alkali solutions and knives to scrape the shower room. Perform gentle cleaning and maintenance periodically. Keep the door open to have the shower area well ventilated.

5
years **GUARANTEE**

Kame grants a 5 year warranty against manufacturing defects, providing the installation, cleaning and maintenance instructions are followed.

level ruler

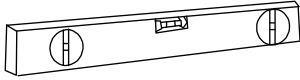

tape measure

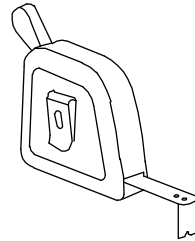

pencil



ruler



3 mm drills



electric drill

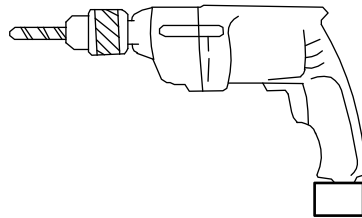

screwdrivers blades

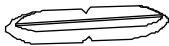

organic glass gun

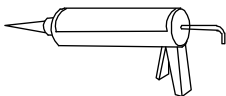

screwdriver

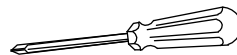



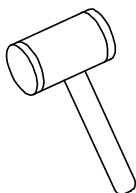





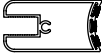
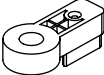



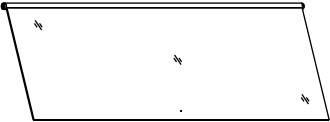

rawhide hammer

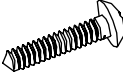

spanner

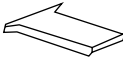

| COMPONENTS | | | |
|------------|-------------------------|---|-----|
| CODE | NAME | MODEL | QTY |
| A | Wall fixing profile |  | 2 |
| B | Vertical chrome profile |  | 2 |
| C | Frame fixer (R) |  | 2 |
| D | Frame fixer (L) |  | 2 |
| E | Outside screw cap |  | 6 |
| F | Inside screw cap |  | 6 |
| G | Sliding glass |  | 2 |
| H | Magnetic strip |  | 1 |

| COMPONENTS | | | |
|------------|------------------|---|-----|
| CODE | NAME | MODEL | QTY |
| I | Expansion pipe |  | 6 |
| J | Twist drills | 3.2  | 1 |
| K | Down weather bar |  | 2 |
| L | Screw ST4x30mm |   | 6 |
| M | Screw ST4x12mm |   | 6 |
| N | Screw ST4.2x25mm |   | 4 |
| O | Handle |  | 2 |
| R | Cover cap |  | 2 |

Kamě

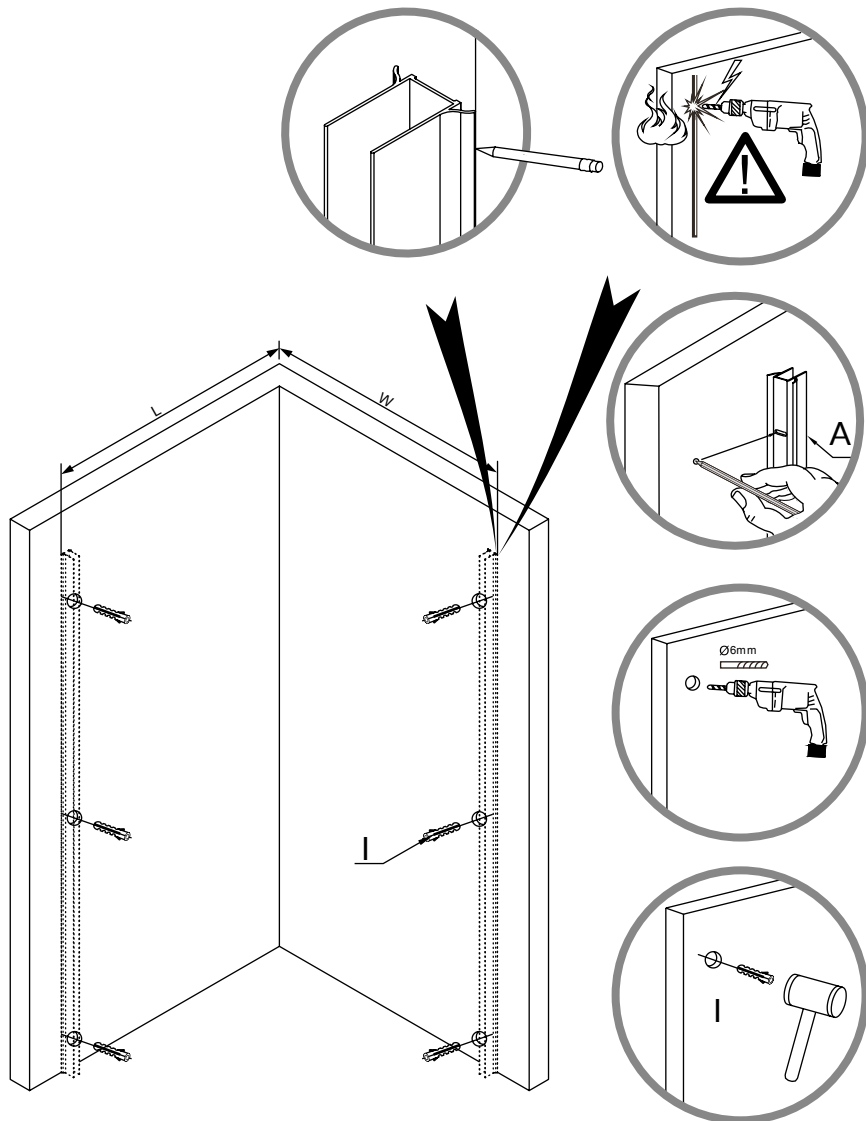

| specifications | 770 x 770 mm | 870 x 870 mm |
|----------------|--------------|--------------|
| size | L | W |
| min | 790 mm | 890 mm |

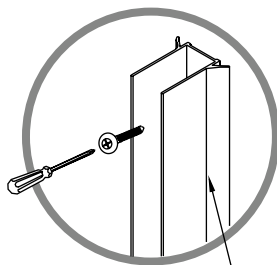

A

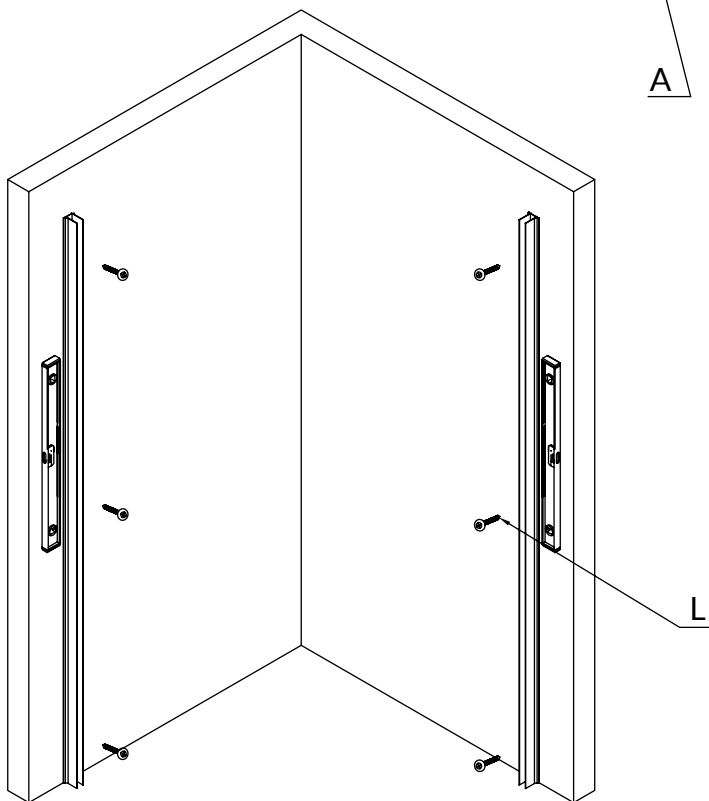

Kamě

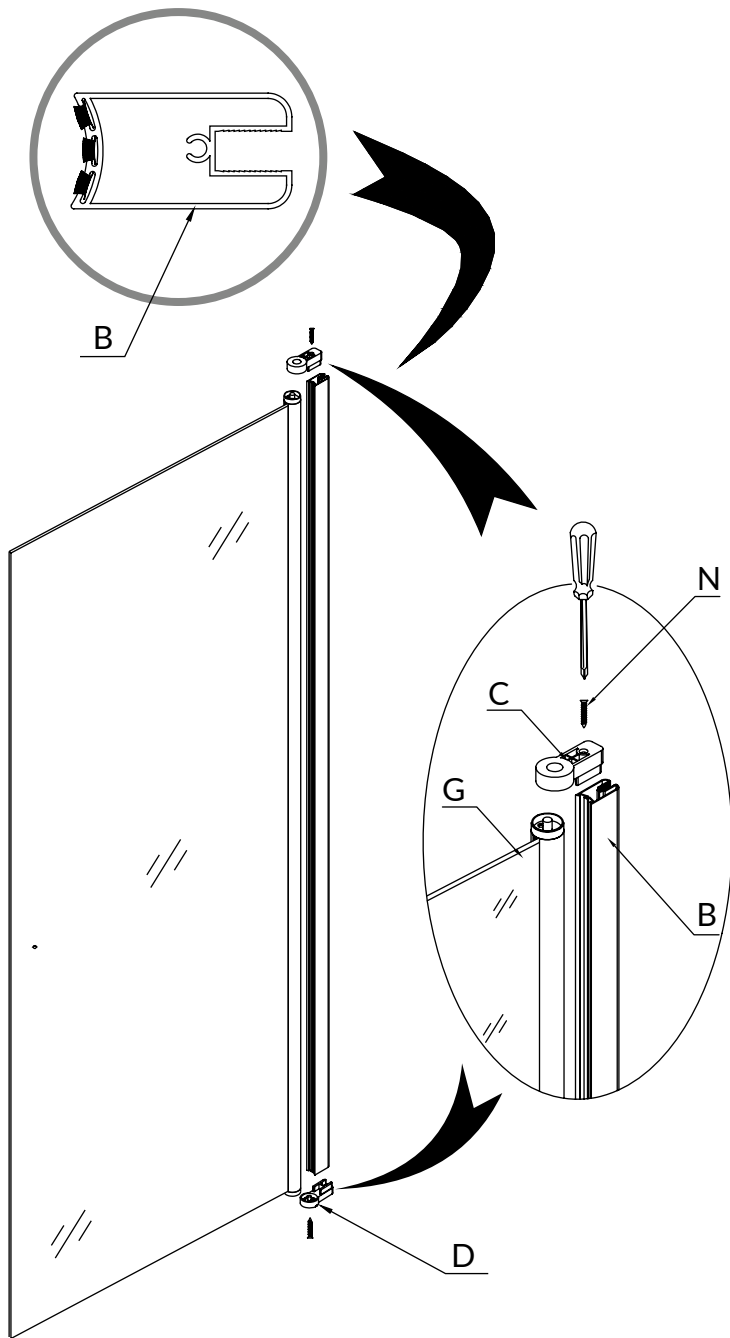

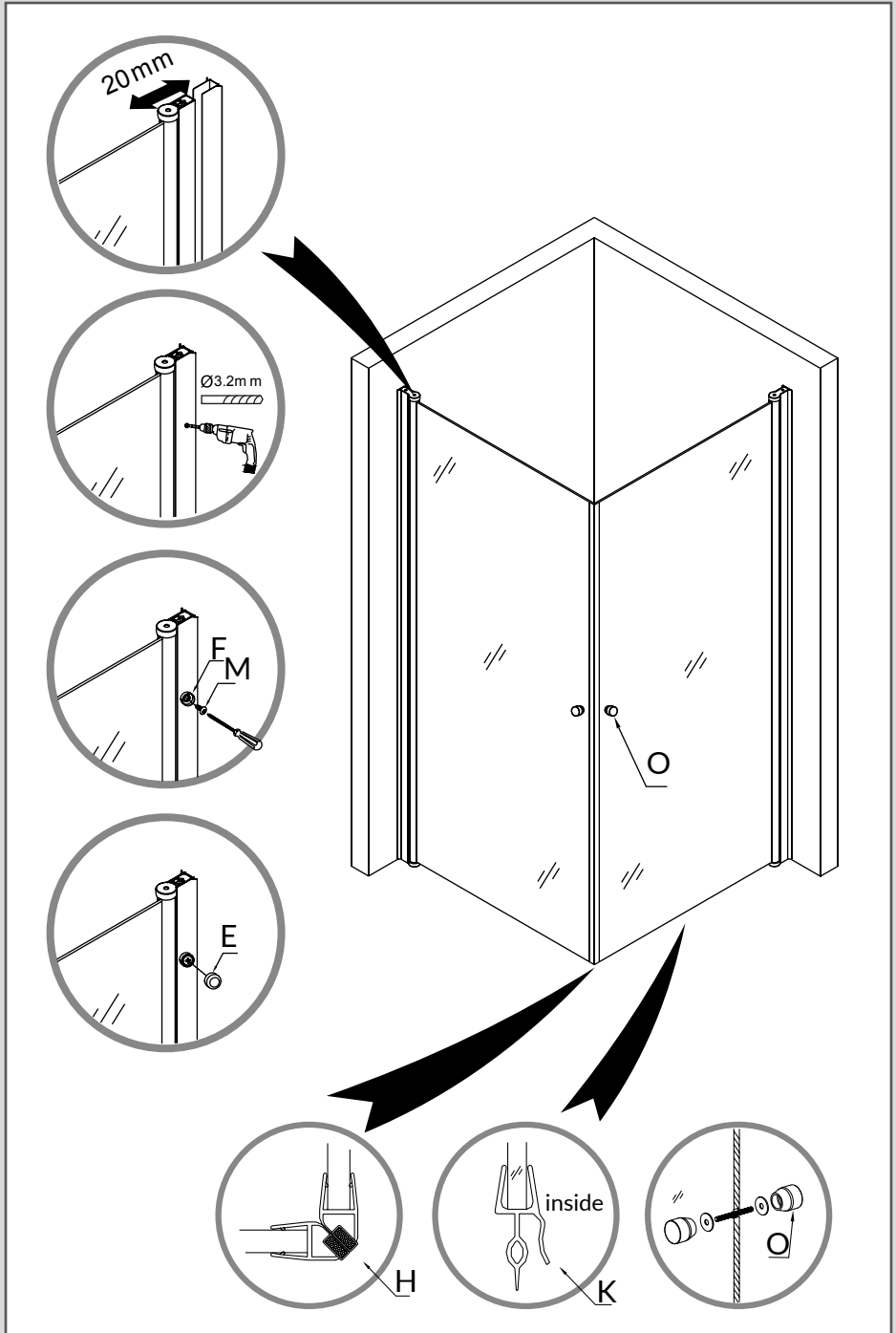

Kamě

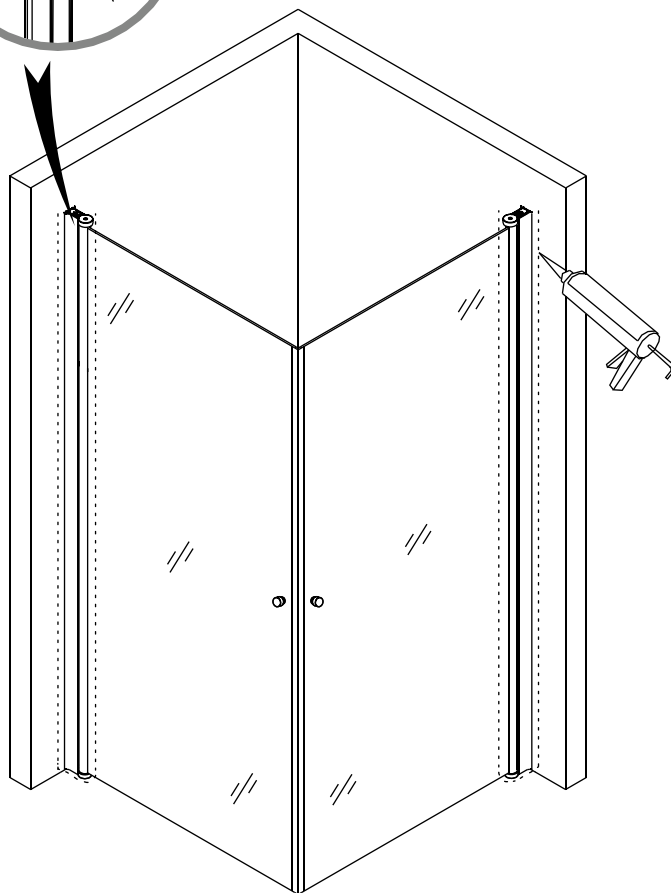
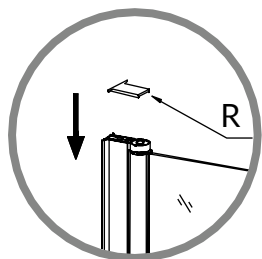

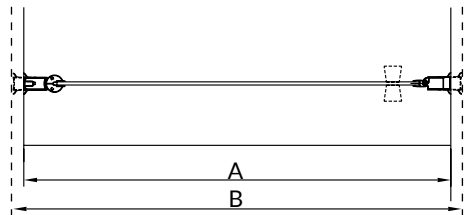
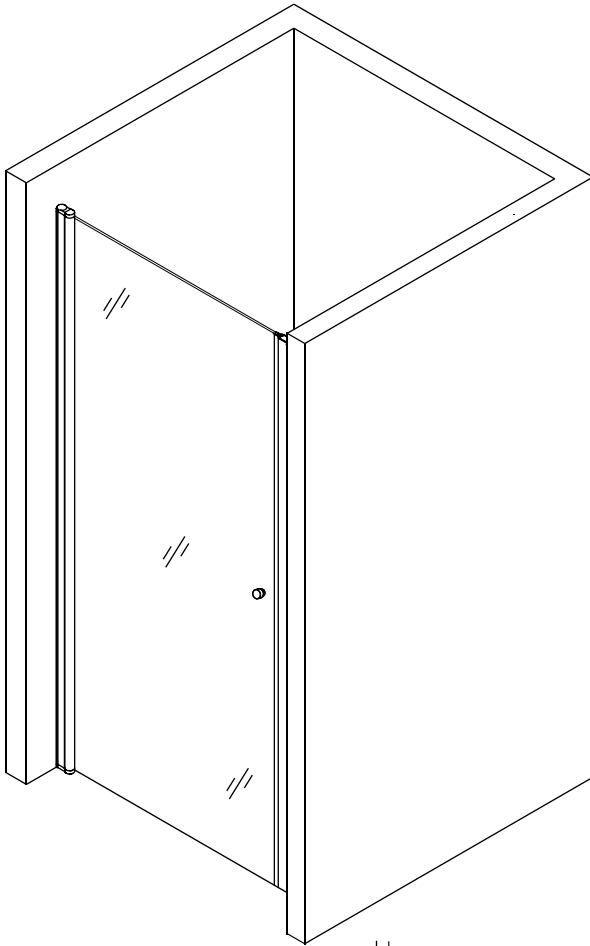

| specifications | 820 x 820 mm | 920 x 920 mm |
|----------------|--------------|--------------|
| min (A) | 820 mm | 920 mm |
| max (B) | 860 mm | 960 mm |

Kamė

Kamė UAB

Kokybės 4, Biruliškių km., Kauno r., LT -54469, Lithuania

Tel: +370 37 709 897 | info@kame.lt | www.kame.lt